



TRENCH SHIELDING AND SHORING



THE LEADING PRODUCER & DISTRIBUTOR OF TRENCH SHIELDING & SHORING EQUIPMENT SINCE 1995



Leading producer and distributor of Trench
Shielding & Shoring equipment since 1995

Pro-Tec Equipment Trench Shield Standards

Pro-Tec Equipment trench shields incorporate standard performance features that help improve productivity while increasing safety on the job.

- Industry's first standard 4-point lifting system
- Industry's strongest knife edge
- Full-length double top rail provides built-in "I" beam strength – on all 4" or thicker trench shields
- Recessed collar assemblies
- Professionally engineered and certified



Knife edges are produced out of thicker, pre-bent steel (eliminating a potential weak point), providing a stronger, longer-lasting knife edge. Competitors and imitators use an extension of the lighter gauge sidewall skin.

PRO SERIES® SHIELDS

Produced for productivity, engineered for safety

Optional foam filling prevents excessive weight build-up from soil and water.

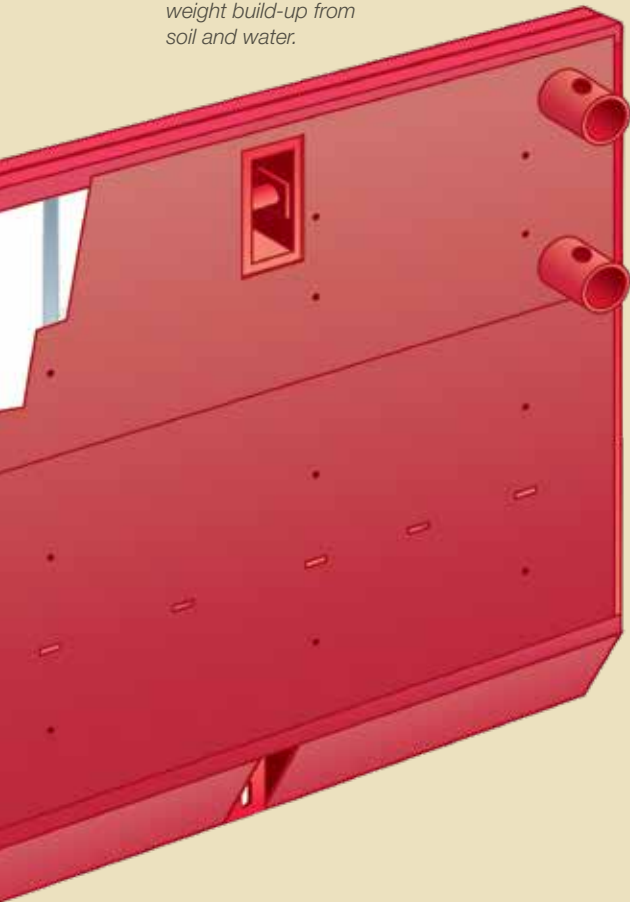

Collar assemblies are encased in heavy wall tubing, inserted between twin end posts.

Collars are 100% perimeter welded to provide maximum durability and strength at these crucial connecting points.



The industry's first standard 4-point lifting system makes assembling, installing, stacking and removing trench shields easier, faster and safer.

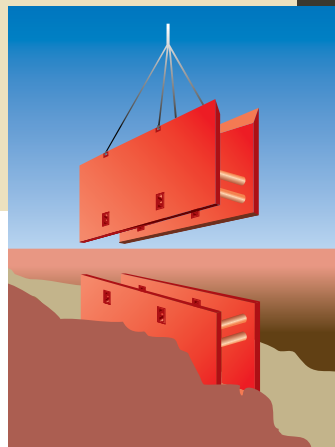



Leading producer and distributor of Trench Shielding & Shoring equipment since 1995

OPTIONS:

What you need when you need it

The Pro-Plus package is available on all Pro-Series trench shields. The Pro-Plus option features three keys upgrades: double outside end post, $\frac{3}{4}$ " thick collars and $\frac{1}{2}$ " x full length push pads. The Pro-Plus option is ideal for rental fleets because it can add usable years to the life of a trench shield.

Pro-Plus Package:

- Double outside end posts: Provide extra protection on the front and back end of the trench shield from excavator bucket damage
- $\frac{3}{4}$ " thick collars: Reduce pin hole deformation and enlargement
- $\frac{1}{2}$ " x full length push pads: Attached to the top of the trench shield, the push pad provides an extra layer of protection from excavator bucket damage

Additional Options:

- **Foam filling:** Excessive weight buildup from soil and water inside of side walls is prevented by foam filling.
- **Extended collars:** The extended collars provide increased usability from standard spreader pipes and are available on all Pro and Pal series trench shields. Extended collars allow the width of trench shield system to be extended in 6" increments, while using the same size spreader pipe.
- **Stacking pockets:** Pro-Tec Equipment's trench shields can be equipped with stacking pockets to connect shields vertically, while restricting lateral movement. With Pro-Tec Equipment's stack pocket locations, all sizes of Pro-Tec Equipment Pro and Pal trench shields may be stacked with each other.
- **Cutouts/Replaceable doors:** Not every project is the same. Some projects require pipe to go through the trench shield. Pro-Tec Equipment can handle that problem by incorporating cutouts into the trench shield. Replaceable doors are also available.

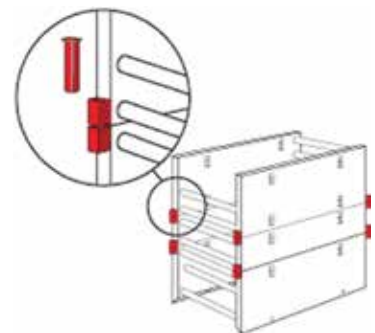
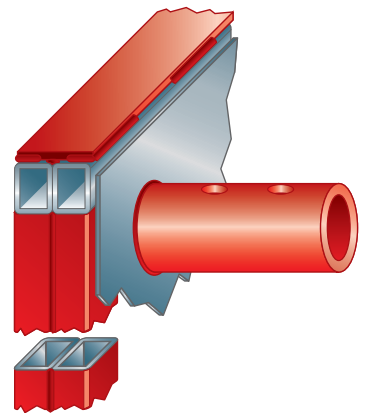
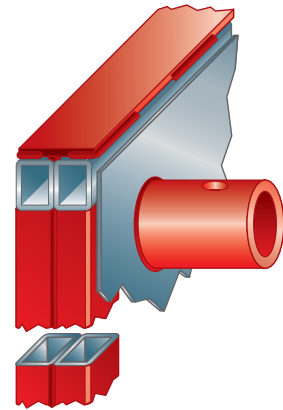

SPREADER SYSTEMS

To Suit Your Job Conditions

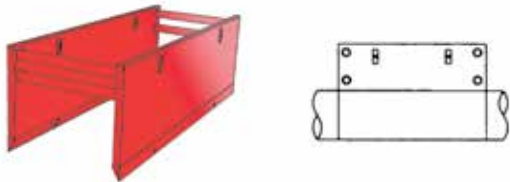

4-PIPE SPREADER SYSTEM

4-PIPE REPAIR

Widely used for jobs involving pipe that must be straddled. Maximum pipe clearance at both ends of shield.

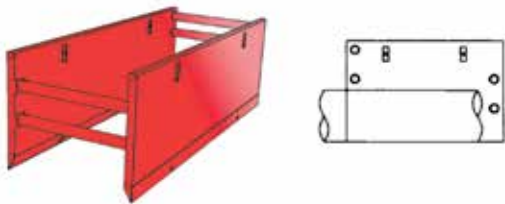

4-PIPE PULL

Front spreaders are centered to allow excavator boom clearance. Rear spreaders provide maximum pipe clearance. Recommended for 16' to 20' long shields.

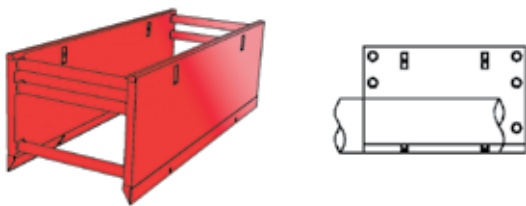

5-PIPE SPREADER SYSTEM

5-PIPE REPAIR

For maximum clearance at both ends, lower spreader pipe can be omitted. For added rigidity, 5th spreader pipe is used.

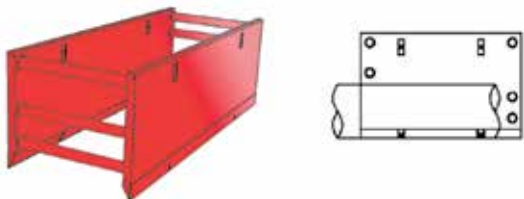

5-PIPE PULL

For maximum rigidity and stability, the 5-pipe pull spreader system is ideal. Recommended for 24' long shields and larger.

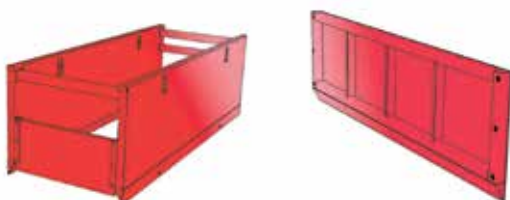

MUD PLATES

Pro-Tec Equipment Mud Plates help keep soil and sand from inside the shield. Plates pin to sidewalls quickly and easily.

PRO SERIES SHIELDS

4", 6" and 8" Double Wall Shields

The Pro Series line of trench shields from Pro-Tec Equipment incorporates performance and safety features that provide increased job safety and productivity. Pro Series trench shields are available in 4", 6" and 8" thick sidewalls. Each is designed to meet the depth and machine capacity for the intended project.

Standard features:

- Industry's first standard 4-point lift system
- Full-length double top rail provides built-in "I" beam strength
- Recessed collar assemblies
- Professional Engineer Certified to meet or exceed O.S.H.A. requirements
- On knife edge shields: the industry's strongest knife edge
- On flat bottom shields: full-length double bottom rail provides built-in "I" beam strength

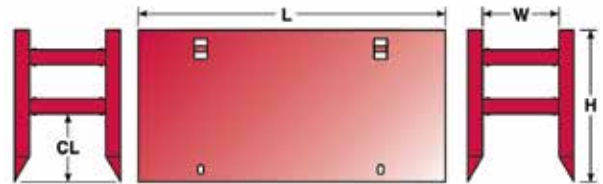

Pro Series - 4" Double Wall Shields

Height x Lgth (ft.)	Model	Weight (Lb.)**	Pipe Clear (in.)	Shield Cap (PSF)*	Depth of Cut (ft.)		
					B	C-60	C-80
4 x 10	PRO 4-410	2920	21	3000	67	50	38
4 x 12	PRO 4-412	3290	21	3000	67	50	38
4 x 16	PRO 4-416	4100	21	1840	41	31	23
4 x 20	PRO 4-420	4880	21	1130	25	19	14
4 x 24	PRO 4-424	5700	21	775	17	13	10
6 x 10	PRO 4-610	3750	41	3000	67	50	38
6 x 12	PRO 4-612	4340	41	3000	67	50	38
6 x 16	PRO 4-616	5440	41	1533	34	25	19
6 x 20	PRO 4-620	6600	41	1111	25	19	14
6 x 24	PRO 4-624	7800	41	791	18	13	10
8 x 10	PRO 4-810	4650	55	2393	53	40	30
8 x 12	PRO 4-812	5390	55	2011	45	34	25
8 x 16	PRO 4-816	6800	55	1533	34	25	19
8 x 20	PRO 4-820	8240	55	1113	25	19	14
8 x 24	PRO 4-824	9850	55	793	18	13	10
10 x 10	PRO 4-1010	5750	70	1723	38	29	22
10 x 12	PRO 4-1012	6640	70	1457	32	24	18
10 x 16	PRO 4-1016	8320	70	1124	25	19	14
10 x 20	PRO 4-1020	9990	70	924	21	15	12
10 x 24	PRO 4-1024	11820	70	791	18	13	10

Pro 6 Series 6" Double Wall Shields

Height x Lgth (ft.)	Model	Weight (Lb.)**	Pipe Clear (in.)	Shield Cap (PSF)*	Depth of Cut (ft.)		
					B	C-60	C-80
4 x 16	PRO 6-416	4650	21	2500	56	42	31
4 x 20	PRO 6-420	5490	21	1545	34	26	19
4 x 24	PRO 6-424	6440	21	1050	23	18	13
4 x 26	PRO 6-426	6860	21	892	20	15	11
4 x 28	PRO 6-428	7320	21	769	17	13	10
6 x 16	PRO 6-616	6190	41	2200	49	37	28
6 x 20	PRO 6-620	7410	41	1500	33	25	19
6 x 24	PRO 6-624	8850	41	1066	24	18	13
6 x 26	PRO 6-626	9430	41	903	20	15	11
6 x 28	PRO 6-628	10250	41	776	17	13	10
8 x 16	PRO 6-816	7740	64	1882	42	31	24
8 x 20	PRO 6-820	9290	64	1528	34	25	19
8 x 24	PRO 6-824	11100	64	1068	24	18	13
8 x 26	PRO 6-826	11800	64	904	20	15	11
8 x 28	PRO 6-828	12660	64	777	17	13	10
10 x 16	PRO 6-1016	9900	85	1422	32	24	18
10 x 20	PRO 6-1020	12000	85	1218	27	20	15
10 x 24	PRO 6-1024	13920	85	1040	23	17	13
10 x 26	PRO 6-1026	14350	85	876	19	15	11
10 x 28	PRO 6-1028	15200	85	780	17	13	10

Other sizes available upon request



Pro 8 Series

Pro Series Options:

- Foam filling – prevents soil and water buildup
- Extended collars
- Pro-Plus Package – adds life and usability
- Cutouts and replaceable doors
- Stacking pockets
- Custom sizes



Pro 6 Series



Pro 4 Series

Pro 8 Series 8" Double Wall Shields

Height x Lgth (ft.)	Model	Weight (Lb.)**	Pipe Clear (in.)	Shield Cap (PSF)*	Depth of Cut (ft.)		
					B	C-60	C-80
4 x 16	PRO 8-416	5280	21	3000	67	50	38
4 x 20	PRO 8-420	6250	21	2117	47	35	26
4 x 24	PRO 8-424	7280	21	1426	32	24	18
4 x 28	PRO 8-428	8250	21	1034	23	17	13
4 x 30	PRO 8-430	8770	21	899	20	15	11
6 x 16	PRO 8-616	6990	41	3000	67	50	38
6 x 20	PRO 8-620	8350	41	2000	44	33	25
6 x 24	PRO 8-624	9790	41	1461	32	24	18
6 x 28	PRO 8-628	11150	41	1055	23	18	13
6 x 30	PRO 8-630	11990	41	915	20	15	11
8 x 16	PRO 8-816	8800	64	2520	56	42	32
8 x 20	PRO 8-820	10470	64	1800	40	30	23
8 x 24	PRO 8-824	12340	64	1463	33	24	18
8 x 28	PRO 8-828	14070	64	1057	23	18	13
8 x 30	PRO 8-830	15000	64	916	20	15	11
10 x 16	PRO 8-1016	10800	85	2083	46	35	26
10 x 20	PRO 8-1020	12900	85	1841	41	31	23
10 x 24	PRO 8-1024	15100	85	1254	28	21	16
10 x 26	PRO 8-1026	15990	85	1140	25	19	14
10 x 28	PRO 8-1028	17100	85	1020	23	17	13
10 x 30	PRO 8-1030	18200	85	900	20	15	11

8" Schedule 80 Spreader Pipe Including Pins & Keepers

4 Pipe Spreader Sets

Model	Inside Width (in.)	Weight (Lb.)
H 4- 24	24	470
H 4- 30	30	560
H 4- 36	36	650
H 4- 42	42	740
H 4- 48	48	820
H 4- 60	60	1010
H 4- 72	72	1170
H 4- 84	84	1350
H 4- 96	96	1510
H 4- 108	108	1692
H 4- 120	120	1860
H 4- 132	132	2040
H 4- 144	144	2210

5 Pipe Spreader Sets

Model	Inside Width (in.)	Weight (Lb.)
H 5- 24	24	590
H 5- 30	30	690
H 5- 36	36	800
H 5- 42	42	910
H 5- 48	48	1020
H 5- 60	60	1240
H 5- 72	72	1450
H 5- 84	84	1670
H 5- 96	96	1890
H 5- 108	108	2110
H 5- 120	120	2320
H 5- 132	132	2540
H 5- 144	144	2760

*PSF (pounds per square foot) ratings indicate maximum shield capacities. Depths are based on B, C and C-80 soil types as described in O.S.H.A.'s 29 CFR Part 1926 Subpart P, October 31, 1989 with Type B not exceeding 45 PSF per foot of depth, Type C not exceeding 60 PSF per foot of depth and Type C-80 not exceeding 80 PSF per foot of depth. Determine actual soil pressure and consult manufacturer's Tabulated Data prior to each use.

** Weight of shields = two sidewalls, no spreaders.

PRO HD SERIES

Designed as an extension of the standard Pro Series trench shields, the Pro HD Series offers the same standard and optional features, but delivers exceptional depth ratings for extreme projects. Available in 6" and 8" thick sidewalls.



Standard features:

- Industry's first standard 4-point lift system
- Full-length double top rail provides built-in "I" beam strength
- Recessed collar assemblies
- Professional Engineer Certified to meet or exceed O.S.H.A. requirements
- On knife edge shields: the industry's strongest knife edge
- On flat bottom shields: full-length double bottom rail provides built-in "I" beam strength

Pro Series Options:

- Foam filling – prevents soil and water buildup
- Extended collars
- Pro-Plus Package – adds life and usability
- Cutouts and replaceable doors
- Stacking pockets
- Custom sizes

Railing Post System

Pro-Tec Equipment's Railing Post System serves as an extra precautionary measure, providing temporary railing around excavations that involve trench shoring and shielding.

Certified by a Registered Professional Engineer to meet or exceed O.S.H.A. handrail standards, the Railing Post Systems are two-piece, lightweight systems that can be adapted to work with steel and aluminum trench shoring and shielding systems.

Railing Post System features:

- Two-piece system
- Standard rail post and saddles (which come in three sizes to work with aluminum or steel trench shields)
- Lightweight system
- Uses standard 2 x 4 lumber (not provided by Pro-Tec Equipment)
- Registered Professional Engineer specification data sheet



Pro HD Series - Heavy Duty 6" Double Wall Shields

Height x Lgth (ft.)	Model	Weight (Lb.)**	Pipe Clear (in.)	Shield Cap (PSF)*	Depth of Cut (ft.)		
					B	C-60	C-80
8 x 24	PRO HD6-824	13100	64	1500	33	25	19
8 x 28	PRO HD6-828	14700	64	1058	24	18	13
10 x 16	PRO HD6-1016	11200	85	1551	34	26	19
10 x 20	PRO HD6-1020	14150	85	2010	45	34	25
10 x 24	PRO HD6-1024	18010	85	1481	33	25	19

*PSF (pounds per square foot) ratings indicate maximum shield capacities. Depths are based on B, C and C-80 soil types as described in O.S.H.A.'s 29 CFR Part 1926 Subpart P, October 31, 1989 with Type B not exceeding 45 PSF per foot of depth, Type C not exceeding 60 PSF per foot of depth and Type C-80 not exceeding 80 PSF per foot of depth. Determine actual soil pressure and consult manufacturer's Tabulated Data prior to each use.

** Weight of shields = two sidewalls, no spreaders.

Pro HD Series - Heavy Duty 8" Double Wall Shields

Height x Lgth (ft.)	Model	Weight (Lb.)**	Pipe Clear (in.)	Shield Cap (PSF)*	Depth of Cut (ft.)		
					B	C-60	C-80
8 x 20	PRO HD8-820	11180	64	2396	53	40	30
8 x 24	PRO HD8-824	15870	64	1902	42	32	24
8 x 28	PRO HD8-828	23130	64	1800	40	30	23
8 x 30	PRO HD8-830	23250	64	1500	33	25	19
8 x 32	PRO HD8-832	28650	64	1500	33	25	19
10 x 20	PRO HD8-1020	16600	85	2120	47	35	27
10 x 24	PRO HD8-1024	18470	85	1879	42	31	23
10 x 28	PRO HD8-1028	26000	85	1800	40	30	23
10 x 30	PRO HD8-1030	29380	85	1500	33	25	19
10 x 32	PRO HD8-1032	30560	85	1488	33	25	19

10' high shields may require 10" sch. 120 spreaders; contact Pro-Tec Equipment for details.

HIGH CLEARANCE ARCHES

Pro-Tec Equipment has two models of High Clearances Arches designed to meet the different requirements of a wide range of projects.

High Clearance Arch

The Pro-Tec Equipment Standard High Clearance Arch is designed to allow enough clearance for large diameter pipe, vaults, boring pits and other applications.

- Provides 10 feet of vertical clearance when used on a 10' tall trench shield
- Provides 8 feet of vertical clearance when used on an 8' tall trench shield.
- Designed to fit on all 8- and 10-foot tall Pro Series trench shields*
- Full range of bolt-on extensions to provide up to 20' of internal width
- Professional Engineer Certified to meet or exceed O.S.H.A. requirements

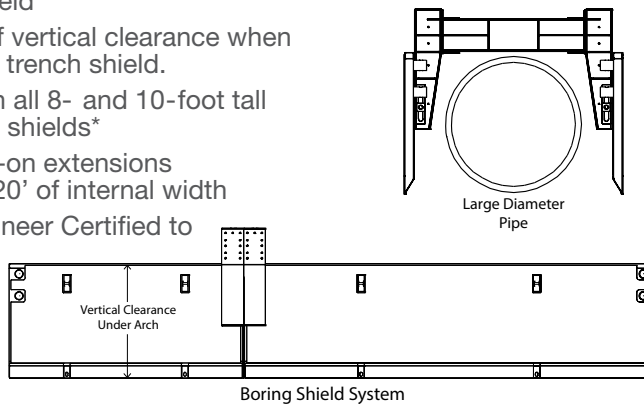

High Clearance Arch

Model	Description \ Length	Weight (Lb.)
HC-ARCH	(2) 18" WIDE LEGS	2800
EX-12	1' EXTENSION	660
EX-24	2' EXTENSION	820
EX-36	3' EXTENSION	980
EX-48	4' EXTENSION	1180
EX-60	5' EXTENSION	1390
EX-72	6' EXTENSION	1500
EX-84	7' EXTENSION	1660
EX-96	8' EXTENSION	1820
EX-108	9' EXTENSION	1960
EX-120	10' EXTENSION	2080
EX-132	11' EXTENSION	2240
EX-144	12' EXTENSION	2390
EX-156	13' EXTENSION	2550
EX-168	14' EXTENSION	2720
EX-180	15' EXTENSION	2880
EX-192	16' EXTENSION	3040
EX-204	17' EXTENSION	3190

Ultra High Clearance Arch

Pro-Tec Equipment's Ultra High Clearance Arch is designed for those projects that require maximum vertical pipe clearance. The Ultra High Clearance Arch is designed to incorporate two stacked trench shields (the top shield inverted) to achieve the desired clearance.

- Provides 14 feet of vertical clearance when using a 10' tall bottom shield
- Provides 12 feet of vertical clearance when using an 8' tall bottom shield
- Designed to fit 8- and 10-foot tall Pro 6 and Pro 8 trench shields*
- Full range of bolt-on extensions to provide up to 20' of internal width
- Professional Engineer Certified to meet or exceed O.S.H.A. requirements

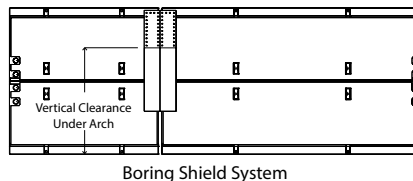

Can easily pin on to new or existing Trench Shields. Custom Designs available

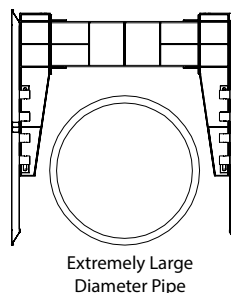

Ultra High Clearance Arch

Model	Description \ Length	Weight (Lb.)
Ultra HC-ARCH	(2) 24" WIDE LEGS	5860
U-EX-12	1' EXTENSION	900
U-EX-24	2' EXTENSION	1260
U-EX-36	3' EXTENSION	1430
U-EX-48	4' EXTENSION	1820
U-EX-60	5' EXTENSION	2270
U-EX-72	6' EXTENSION	2180
U-EX-84	7' EXTENSION	2490
U-EX-96	8' EXTENSION	2690
U-EX-108	9' EXTENSION	2880
U-EX-120	10' EXTENSION	3100
U-EX-132	11' EXTENSION	3350
U-EX-144	12' EXTENSION	3540
U-EX-156	13' EXTENSION	3950
U-EX-168	14' EXTENSION	4180
U-EX-180	15' EXTENSION	4560
U-EX-192	16' EXTENSION	4860

*Collars on trench shields require special horizontal hole; contact Pro-Tec Equipment for details.

MANHOLE SHIELDS

4" SINGLE & DOUBLE WALL

The Pro-Tec Equipment Man 4 Series is specifically designed to increase production on manhole installation projects.

Standard features:

- Industry's first standard 4-point lift system
- Full-length double top rail provides built-in "I" beam strength
- Wrap-around wings
- Professional Engineer Certified to meet or exceed O.S.H.A. requirements
- On knife edge shields: the industry's strongest knife edge
- On flat bottom shields: full-length double bottom rail provides built-in "I" beam strength
- Available in single and double wall models
- Includes connected, 5" schedule 80 spreader pipe

Man 4 Series Options:

- Foam filling – prevents soil and water buildup (on double wall shields)
- Cutouts and replaceable doors
- Stacking pockets
- Custom sizes

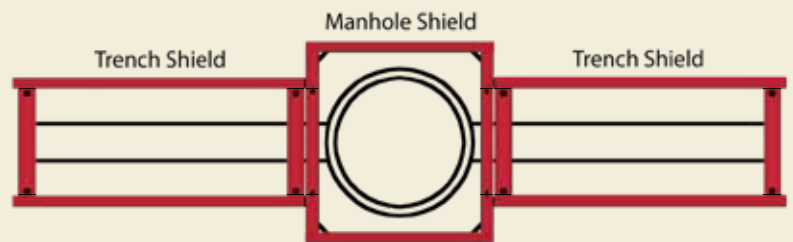

Top View of a pipe line project showing how to properly utilize a manhole shield, with trench shields.

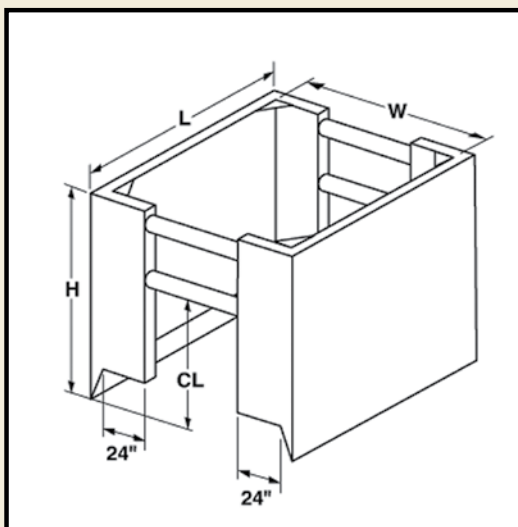

Manhole shields – 4" Single and Double Wall

Height x Lgth x Width (ft.)	Model	Wall	Weight (Lb.)**	Pipe Clear (in.)	Shield Cap (PSF)*	Depth of Cut (ft.)		
						B	C-60	C-80
4 X 8 X 8	MAN 4-48 S	4" Single	2700	24	1800	40	30	23
4 X 10 X 10	MAN 4-410 S	4" Single	3000	24	1380	31	23	17
8 X 8 X 8	MAN 4-88 S	4" Single	4200	48	1140	25	19	14
8 X 10 X 10	MAN 4-810 S	4" Single	4900	48	780	17	13	10
8 X 12 X 12	MAN 4-812 S	4" Single	5600	48	600	13	10	8
4 X 8 X 8	MAN 4-48	4" Double	3100	24	3000	67	50	38
4 X 10 X 10	MAN 4-410	4" Double	3600	24	3000	67	50	38
4 X 12 X 12	MAN 4-412	4" Double	4200	24	2100	47	35	26
8 X 8 X 8	MAN 4-88	4" Double	4990	48	2400	53	40	30
8 X 10 X 10	MAN 4-810	4" Double	5890	48	2100	47	35	26
8 X 12 X 12	MAN 4-812	4" Double	6750	48	1680	37	28	21
8 X 14 X 14	MAN 4-814	4" Double	7700	48	1500	33	25	19

*PSF (pounds per square foot) ratings indicate maximum shield capacities. Depths are based on B, C and C-80 soil types as described in O.S.H.A.'s 29 CFR Part 1926 Subpart P, October 31, 1989 with Type B not exceeding 45 PSF per foot of depth, Type C not exceeding 60 PSF per foot of depth and Type C-80 not exceeding 80 PSF per foot of depth. Determine actual soil pressure and consult manufacturer's Tabulated Data prior to each use.

** Weight of shields = two sidewalls, no spreaders.

MANHOLE SHIELDS

OCTAGON MANHOLE SHIELDS

Pro-Tec Equipment's Octagon Manhole Shield (OMH) combines the strength, durability and safety that is synonymous with a Pro-Tec Equipment trench shield, with the mobility of a lightweight trench shield.

Standard features:

- Unique shape enables a potential savings of 3 cubic yards of fill
- Single wall design
- Professional Engineer Certified to meet or exceed O.S.H.A. requirements
- Stacking pockets
- Lifting rings

Octagon Manhole Options:

- Trapezoidal cutouts and replaceable doors
- Custom size

Octagon Manhole Shields

Model	Shield Cap (PSF)*	Depth of Cut (ft.)			Ht x Lgth x Wdth (ft.)			Weight (Lb.)
		B	C-60	C-80				
OMH - 488	1560	35	26	20	4 X	8 X	8	2450
OMH - 41010	1380	31	23	17	4 X	10 X	10	3160
OMH - 41212***	1260	28	21	16	4 X	12 X	12	4100
OMH - 688	1560	35	26	20	6 X	8 X	8	3500
OMH - 61010	1380	31	23	17	6 X	10 X	10	4450
OMH - 61212***	1260	28	21	16	6 X	12 X	12	6290
OMH - 888	1560	35	26	20	8 X	8 X	8	4400
OMH - 81010	1380	31	23	17	8 X	10 X	10	5200
OMH - 81212***	1260	28	21	16	8 X	12 X	12	7000

***Ships in two pieces



PRO-CORR ROUND MANHOLE SHIELDS

Pro-Tec Equipment's Round Manhole Shield (Pro-Corr) is designed to be used by lighter-duty excavators and rubber-tired backhoes.

Standard features:

- Stacking pockets
- 24" adjustable legs
- Lifting eyes
- Professional Engineer Certified to meet or exceed O.S.H.A. requirements



Pro-Corr Options:

- Cutouts and replaceable doors
- Custom sizes

Round Manhole Shields

Model	Height (in.)	O.D. (in.)	Shield Cap (PSF)*	Depth of Cut (ft.)			3 Cutouts with Bolt On Doors	Weight (Lb.)
				B	C-60	C-80		
PC - 48	48	98	1920	43	32	24	960	
PC - 48.5	48	104	1920	43	32	24	1020	
PC - 410	48	122	1920	43	32	24	1200	
PC - 88	96	98	1920	43	32	24	1600	
PC - 88.5	96	104	1920	43	32	24	1715	
PC - 810	96	122	1920	43	32	24	2030	
PC - 88 CU	96	98	1920	43	32	24 40" / 40" / 24"	2300	
PC - 88.5 CU	96	104	1920	43	32	24 40" / 40" / 24"	2420	
PC - 810 CU	96	122	1920	43	32	24 48" / 48" / 30"	2775	

Includes: Set of (4) adjustable legs, stack pockets and lifting lugs

*PSF (pounds per square foot) ratings indicate maximum shield capacities. Depths are based on B, C and C-80 soil types as described in O.S.H.A.'s 29 CFR Part 1926 Subpart P, October 31, 1989 with Type B not exceeding 45 PSF per foot of depth, Type C not exceeding 60 PSF per foot of depth and Type C-80 not exceeding 80 PSF per foot of depth. Determine actual soil pressure and consult manufacturer's Tabulated Data prior to each use.

4-SIDED MANHOLE SHIELDS (TAP BOXES)

Pro-Tec Equipment's 4-Sided Manhole Shields (tap boxes) are available in 3" and 4" sidewalls, and are designed to allow complete protection on all sides.

Standard features:

- Industry's first standard 4-point lift system
- Full-length double top rail provides built-in "I" beam strength
- Professional Engineer Certified to meet or exceed O.S.H.A. requirements
- On knife edge shields: the industry's strongest knife edge
- On flat bottom shields: full-length double bottom rail provides built-in "I" beam strength



4-Sided Manhole Shield (tap boxes) options:

- Foam filling – prevents soil and water buildup
- Cutouts and replaceable doors
- Stacking pockets
- Custom sizes

PAL SERIES

Lightweight 3" and 4" Shields

The Pro-Tec Equipment Pal Series trench shields, available in 3" and 4" sidewalls, are specifically designed for municipal utility installation/maintenance, water, sewer, gas, fiber optic and cable installation, among other projects where rubber tire backhoes and small excavators are used.

LIGHTWEIGHT 4" SHIELDS

Pal 4 Standard features:

- Industry's first standard 4-point lift system
- Full-length double top rail provides built-in "I" beam strength
- Recessed collar assemblies
- Choice of 4" or 7" collars
- Professional Engineer Certified to meet or exceed O.S.H.A. requirements
- On knife edge shields: the industry's strongest knife edge
- On flat bottom shields: full-length double bottom rail provides built-in "I" beam strength

Pal 4 Series options:

- Foam filling – prevents soil and water buildup
- Extended collars
- Cutouts and replaceable doors
- Stacking pockets
- Custom sizes



PAL 4 SERIES TRENCH SHIELDING

Height x Lgth (ft.)	Model	Shield Wt. (Lb.)** (4" Collars)	Shield Wt. (Lb.)** (7" Collars)	Pipe Clear (in.)	Shield Cap (PSF)*	Depth of Cut (ft.)		
						B	C-60	C-80
4 x 8	PAL 4-48	1800	2100	24	2400	53	40	30
4 x 10	PAL 4-410	2190	2490	24	2100	47	35	26
4 x 12	PAL 4-412	2490	2790	24	1740	39	29	22
4 x 14	PAL 4-414	3000	3300	24	1500	33	25	19
4 x 16	PAL 4-416	3200	3500	24	1140	25	19	14
4 x 20	PAL 4-420	3850	4150	24	780	17	13	10
4 x 24	PAL 4-424	N/A	5120	24	540	12	9	7
6 x 8	PAL 4-68	2490	2790	36	2400	53	40	30
6 x 10	PAL 4-610	2950	3250	36	2100	47	35	26
6 x 12	PAL 4-612	3390	3690	36	1740	39	29	22
6 x 14	PAL 4-614	3850	4150	36	1500	33	25	19
6 x 16	PAL 4-616	4300	4600	36	1140	25	19	14
6 x 20	PAL 4-620	5250	5550	36	780	17	13	10
6 x 24	PAL 4-624	N/A	6530	36	540	12	9	7
8 x 8	PAL 4-88	3100	3400	48	2400	53	40	30
8 x 10	PAL 4-810	3650	3950	48	2100	47	35	26
8 x 12	PAL 4-812	4250	4550	48	1740	39	29	22
8 x 14	PAL 4-814	4800	5100	48	1500	33	25	19
8 x 16	PAL 4-816	5400	5700	48	1140	25	19	14
8 x 20	PAL 4-820	6750	7050	48	780	17	13	10
8 x 24	PAL 4-824	N/A	8380	48	540	12	9	7

5" Schedule 80 Spreader Pipe Including Pins & Keepers

4 Pipe Spreader Sets

Model	Inside Width (in.)	Weight (Lb.)
M 4-24	24	220
M 4-30	30	270
M 4-36	36	310
M 4-42	42	350
M 4-48	48	390
M 4-60	60	470
M 4-72	72	560
M 4-84	84	640
M 4-96	96	730
M 4-108	108	810
M 4-120	120	890
M 4-132	132	1000
M 4-144	144	1100

8" Schedule 80 Spreader Pipe Including Pins & Keepers

4 Pipe Spreader Sets

Model	Inside Width (in.)	Weight (Lb.)
H 4-24	24	470
H 4-30	30	560
H 4-36	36	650
H 4-42	42	740
H 4-48	48	820
H 4-60	60	1010
H 4-72	72	1170
H 4-84	84	1350
H 4-96	96	1510
H 4-108	108	1692
H 4-120	120	1860
H 4-132	132	2040
H 4-144	144	2210

PAL SERIES

Lightweight 3" and 4" Shields

LIGHTWEIGHT 3" SHIELDS

Pal 3 Standard features:

- Industry's first standard 4-point lift system
- Recessed collar assemblies
- Choice of 3" or 4" collars
- Professional Engineer Certified to meet or exceed O.S.H.A. requirements
- On knife edge shields: the industry's strongest knife edge

Pal 3 Series options:

- Foam Filling – prevents soil and water buildup
- Extended collars
- Cutouts and replaceable doors
- Single or double wall models
- Stacking pockets
- Custom sizes



4" Schedule 40 Pipe Including Pins & Keepers

4 Pipe Spreader Sets

Model	Inside Width (in.)	Weight (Lb.)
L 4- 24	24	140
L 4- 30	30	170
L 4- 36	36	190
L 4- 42	42	210
L 4- 48	48	230
L 4- 60	60	270
L 4- 72	72	320
L 4- 84	84	360
L 4- 96	96	400
L 4- 108	108	450
L 4- 120	120	490
L 4- 144	144	580

5" Schedule 80 Pipe Including Pins & Keepers

4 Pipe Spreader Sets

Model	Inside Width (in.)	Weight (Lb.)
M 4- 24	24	220
M 4- 30	30	270
M 4- 36	36	310
M 4- 42	42	350
M 4- 48	48	390
M 4- 60	60	470
M 4- 72	72	560
M 4- 84	84	640
M 4- 96	96	730
M 4- 108	108	810
M 4- 120	120	890
M 4- 144	144	1100

*PSF (pounds per square foot) ratings indicate maximum shield capacities. Depths are based on B, C and C-80 soil types as described in O.S.H.A.'s 29 CFR Part 1926 Subpart P, October 31, 1989 with Type B not exceeding 45 PSF per foot of depth, Type C not exceeding 60 PSF per foot of depth and Type C-80 not exceeding 80 PSF per foot of depth. Determine actual soil pressure and consult manufacturer's Tabulated Data prior to each use.

** Weight of shields = two sidewalls, no spreaders.

PAL Series - 3" Single Wall Shields

Height x Lgth (ft.)	Model	Weight (Lb.)**	Pipe Clear (in.)	Shield Cap (PSF)*	Depth of Cut (ft.)		
					B	C-60	C-80
4 x 4	PAL 3-44 S	790	24	3000	67	50	38
4 x 6	PAL 3-46 S	1050	24	1851	41	31	23
4 x 8	PAL 3-48 S	1250	24	1009	22	17	13
4 x 10	PAL 3-410 S	1490	24	647	14	11	8
4 x 12	PAL 3-412 S	1790	24	500	11	8	6
6 x 4	PAL 3-64 S	990	36	1380	31	23	17
6 x 6	PAL 3-66 S	1290	36	960	21	16	12
6 x 8	PAL 3-68 S	1590	36	770	17	13	10
6 x 10	PAL 3-610 S	1990	36	590	13	10	7
6 x 12	PAL 3-612 S	2350	36	500	11	8	6
8 x 4	PAL 3-84 S	1350	36	1500	33	25	19
8 x 6	PAL 3-86 S	1700	36	1020	23	17	13
8 x 8	PAL 3-88 S	1990	36	840	19	14	11
8 x 10	PAL 3-810 S	2750	36	660	15	11	8
8 x 12	PAL 3-812 S	3200	36	480	11	8	6

PAL Series - 3" Double Wall Shields

Height x Lgth (ft.)	Model	Weight (Lb.)**	Pipe Clear (in.)	Shield Cap (PSF)*	Depth of Cut (ft.)		
					B	C-60	C-80
4 x 6	PAL 3-46	1170	24	3000	67	50	38
4 x 8	PAL 3-48	1460	24	2830	63	47	35
4 x 10	PAL 3-410	1740	24	1770	39	39	22
4 x 12	PAL 3-412	2120	24	1080	24	18	14
4 x 16	PAL 3-416	2590	24	680	15	11	9
6 x 6	PAL 3-66	1630	36	3000	67	50	38
6 x 8	PAL 3-68	2060	36	2790	62	47	35
6 x 10	PAL 3-610	2510	36	1500	33	25	19
6 x 12	PAL 3-612	2960	36	1080	24	18	14
6 x 16	PAL 3-616	3700	36	680	15	11	9
8 x 6	PAL 3-86	2100	48	2040	45	34	26
8 x 8	PAL 3-88	2590	48	1740	39	29	22
8 x 10	PAL 3-810	3220	48	1320	29	22	17
8 x 12	PAL 3-812	3800	48	1080	24	18	14
8 x 16	PAL 3-816	4850	48	680	15	11	9

SHEET PILE

Steel Overlap Sheeting

The Pro-Tec Equipment Steel Overlap Sheet Pile (non-watertight) is high strength and durable. It is designed to be ideal for shoring and bulk heading the ends or sides of trench shields, or for use anywhere locking sheets are not required.

- Strong, durable, high-strength
- Overlap design allows easy installation

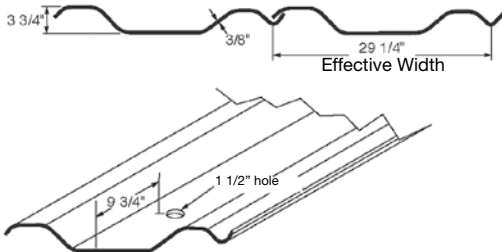

Model	Length	Weight (Lb.)
OLS-144	12'	540
OLS-168	14'	630
OLS-192	16'	720
OLS-216	18'	810
OLS-240	20'	900
OLS-288	24'	1070

Engineering Data	
Area	A = 13.32 in ²
Moment of Inertia (Per Sheet)	I = 24.45in ⁴
Section Modulus (Per Sheet)	S = 12.83in ³
Radius of Gyration (Per Sheet)	R = 1.355 in
Yield Strength	Fy = 50,000#/in ²

Consult registered professional engineering for site specific design prior to use.

Aluminum Overlap Sheet Pile

Pro-Tec Equipment's Aluminum Overlap Sheet Pile (non-watertight) is a lightweight overlap sheet pile. It is designed to be used as bulk heading for closing off any open sides of an aluminum trench shield.

- Easily transported
- Overlap design allows easy installation

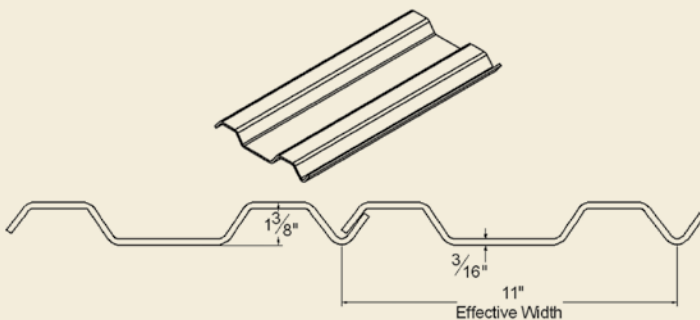

Engineering Data	
Area	A= 2.871in ²
Moment of Inertia (Per Sheet)	I = 0.689in ⁴
Section Modulus (Per Sheet)	S = 0.994in ³
Radius of Gyration (Per Sheet)	R = 0.490in
Yield Strength	Aluminum (6061-T6)

Model	Length	Weight (Lb.)
AOLS-60	5'	16
AOLS-72	6'	19
AOLS-96	8'	25
AOLS-120	10'	31
AOLS-144	12'	37

Consult registered professional engineering for site specific design prior to use.

ALUMINUM TRENCH SHIELDS

ATS Series

The Pro-Tec Equipment Aluminum Trench Shield (ATS) Series is a lightweight trench shield system designed to be used by rubber-tired backhoes and loaders. The ATS is ideal for municipalities and utility contractors.



Standard features:

- Industry's first standard 4-point lift system
- Smooth wall panel design
- Foam filling – prevents soil and water buildup
- Accepts telescoping spreaders (TS4 Spreader)
- Flat bottom
- Professional Engineer Certified to meet or exceed O.S.H.A. requirements

ATS Series options:

- Adaptors to allow use of L-Class (4") or M-Class (5") spreaders pipe
- Aluminum built-in knife edge
- Steel bolt-on knife edge
- Cutout and replaceable doors
- Stacking pockets
- Wheel kits
- Custom sizes

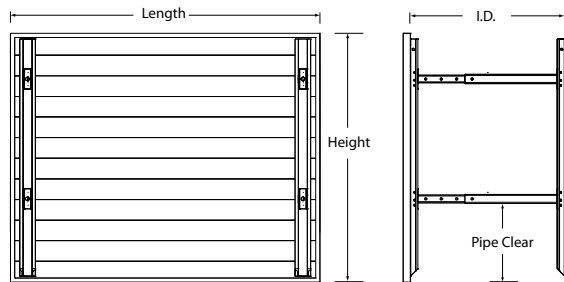

Railing Post System



Pro-Tec Equipment's Railing Post System serves as an extra precautionary measure, providing temporary railing around excavations that involve trench shoring and shielding.

Certified by a Registered Professional Engineer to meet or exceed O.S.H.A. standards, the Railing Post Systems are two-piece, lightweight systems that can be adapted to work with steel and aluminum trench shoring and shielding systems.

Railing Post System features:

- Two-piece system
- Standard rail post and saddles (which come in three sizes to work with aluminum or steel trench shields)
- Lightweight system
- Uses standard 2 x 4 lumber (not provided by Pro-Tec Equipment)
- Registered Professional Engineer specification data sheet

2.75" Sidewall: Aluminum Trench Shield (ATS) Series

Height & Lgth (ft.)	Model	Pipe Clear (in.)	Weight (Lb.)**	Shield Cap (PSF)*	Depth of Cut (ft.)		
					B	C-60	C-80
4 X 6	ATS - 46	12	480	1960	44	33	25
4 X 8	ATS - 48	12	590	1470	33	25	18
4 X 10	ATS - 410	12	710	1130	25	19	14
4 X 12	ATS - 412	12	830	764	17	13	10
4 X 14	ATS - 414	12	940	555	12	9	7
4 X 16	ATS - 416	12	1060	421	9	7	5
6 X 6	ATS - 66	30	690	1264	28	21	16
6 X 8	ATS - 68	30	860	960	21	16	12
6 X 10	ATS - 610	30	1030	777	17	13	10
6 X 12	ATS - 612	30	1210	655	15	11	8
6 X 14	ATS - 614	30	1380	556	12	9	7
6 X 16	ATS - 616	30	1550	427	9	7	5
8 X 6	ATS - 86	30	910	1264	28	21	16
8 X 8	ATS - 88	30	1140	960	21	16	12
8 X 10	ATS - 810	30	1360	777	17	13	10
8 X 12	ATS - 812	30	1590	655	15	11	8
8 X 14	ATS - 814	30	1820	555	12	9	7
8 X 16	ATS - 816	30	2040	427	9	7	5

** Weight of shields = two sidewalls, no spreaders.



Telescoping Adjustable Spreader Sets (set of 4)

Model (Sets of 4)	Adjustment (I.D.)	Weight (Lb.)
TS 4 - 1826	18" to 26"	108
TS 4 - 2334	23" to 34"	128
TS 4 - 2844	28" to 44"	153
TS 4 - 3454	34" to 54"	183
TS 4 - 4266	42" to 66"	223
TS 4 - 5288	52" to 88"	273

ALUMINUM TRENCH SHIELDS

MOD Series

The Pro-Tec Equipment MOD Series is a modular aluminum trench shield system that is lightweight and easily transported via pick-up truck. It can be used as a 2-, 3- or 4-sided system with existing components and can be changed on the fly at a jobsite to meet the job's requirements.

Standard features:

- Smooth wall panel design
- Foam filling – prevents soil and water buildup
- Accepts telescoping spreaders (MTS Spreaders)
- Bottom panels can be removed
- 2-way corner posts allow, 2-, 3- or 4-sided configurations
- Professional Engineer Certified to meet or exceed O.S.H.A. requirements

MOD Series Options

- Aluminum built-in knife edge
- Steel bolt-on knife edge
- Wheel kits
- Adjustable legs
- Lifting eyes
- Stacking units
- Custom sizes



Quick and Easy Assembly

1. Attached corner post to one panel. Install pins with handles on the outside.



2. Set back panel, creating an "L". Install pins and keepers.

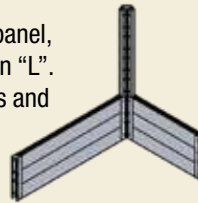

3. Stack and slide panels to desired height before adding 2nd corner post.

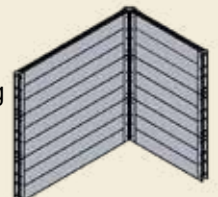

MOD SERIES

Corner Post (2-way)

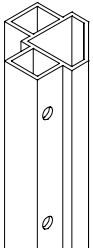

Model	Length	Weight (Lb.)
MC 24	24"	19
MC 48	48"	38
MC 72	72"	56
MC 96	96"	75
MC 120	120"	94

Corner Post (3-way)

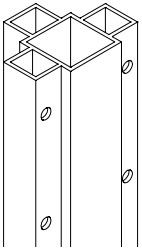

Model	Length	Weight (Lb.)
MC 3-24	24"	25
MC 3-48	48"	51
MC 3-72	72"	76
MC 3-96	96"	101
MC 3-120	120"	127

MOD Panel Depth Chart

Width x Lgth (ft.)	Weight (Lb.)	Maximum Depth of Cut (ft.)		
		B	C -60	C-80
MPS 2 x 3	50	50	50	42
MPS 2 x 4	60	50	42	32
MPS 2 x 6	90	38	28	21
MPS 2 x 8	120	28	21	16
MPS 2 x 10	140	23	17	13
MPS 2 x 12	170	19	14	11
MPS 2 x 14	190	12	9	7

Heavy duty and special length panels are available

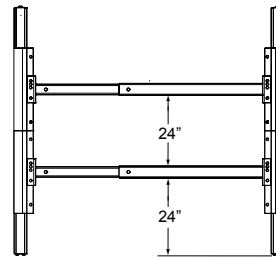

End View
Sectional corner post with adjustable struts

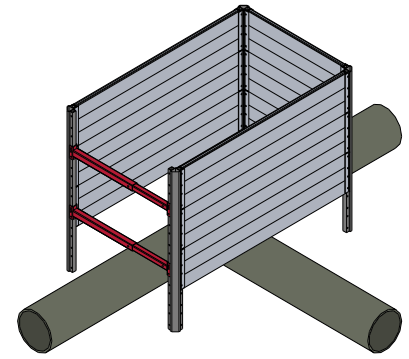

Panels omitted to allow for T-connections or existing utilities

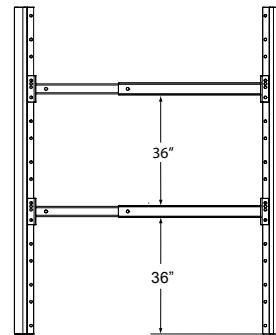

End View
Full length corner post with adjustable struts

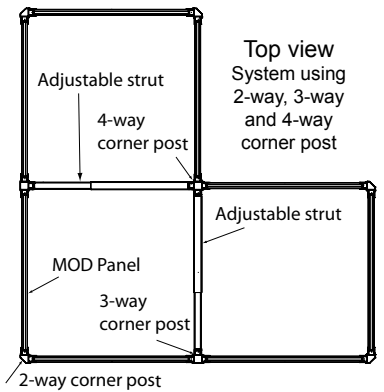

Top view
System using 2-way, 3-way and 4-way corner post

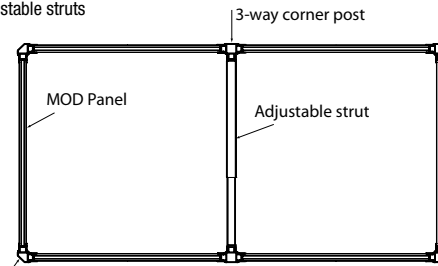

Top View
System using 3-way corner post

Telescoping Adjustable Spreader Sets (set of 4)



Model (Sets of 4)	Adjustment (I.D.)	Weight (Lb.)
TS 4 - 1826	18" to 26"	108
TS 4 - 2334	23" to 34"	128
TS 4 - 2844	28" to 44"	153
TS 4 - 3454	34" to 54"	183
TS 4 - 4266	42" to 66"	223
TS 4 - 5288	52" to 88"	273

Adjustable Spreaders (Inside Panel Dimensions)

Model	Adjustment	Weight (Lb.)
MAS 23	24" to 36"	27
MAS 35	36" to 60"	37
MAS 57	60" to 84"	46
MAS 79	84" to 108"	55

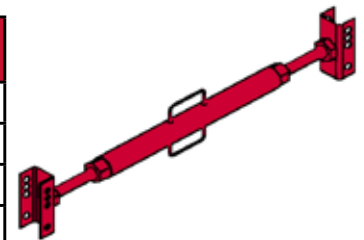

4. Attached 2nd and 3rd corner posts.

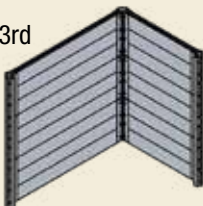

5. Stack and slide panels to desired height. Add 4th corner post.

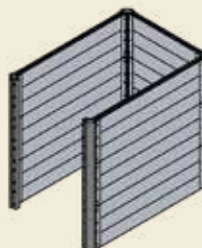

6. Install lift eyes and spreaders in required locations, refer to tabulated data.

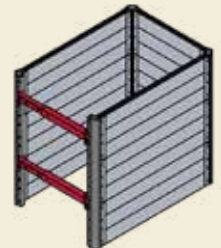

STONE SAVERS

Pro-Tec Equipment's Stone Savers are bedding material containers designed with cost savings in mind. With the Stone Saver, costly bedding material is confined, minimizing losses. Designed with the industry's only rounded, continuous bottom, Pro-Tec Equipment's Stone Savers eliminate welded seams (crucial stress points). Rounded bottoms reduce the plowing effect when moving Stone Savers.



Standard Stone Savers

- Rounded, 1/2" thick bottoms
- 1/4" thick side plates
- Pulling lugs
- Lifting pockets
- 8" schedule 80 pull bar

Standard Stone Saver options:

- Side extensions – further minimize costly material loss
- Front pull bar – allows movement of Stone Saver from either end
- Reinforced pull bar – sleeved with 7" x 1/2" thick pipe, reduces pull arm deformation



Rounded bottom on all the Stone Savers reduces the plowing effect when moving them

Heavy Duty & Extra Wide Stone Savers

- Rounded, 1/2" thick bottoms
- 3/8" thick side plates
- Full-length internal wear bars
- Reinforced ends
- Reinforced arm gussets
- Pulling lugs
- Lifting pockets
- 8" schedule 80 pull bar
- 8" Schedule 120 pull bar on heavy duty Stone Savers 12 cubic yards or larger

Heavy Duty & Extra Wide Stone Saver options:

- Side extensions – further minimize costly material loss
- Front pull bar – allows movement of Stone Saver from either end
- Reinforced pull bar – sleeved with 7" x 1/2" thick pipe, reduces pull arm deformation



Model	Height (in.)	Inside Width (in.)	Inside Length (in.)	Capacity	Weight (Lb.)
SS - 3	36	48	103	3 YDS	3100
SS - 5	36	63	116	5 YDS	4100
SS - 7	48	63	143	7 YDS	5000
SS - 9	48	63	164	9 YDS	5400
SS - 12	48	75	183	12 YDS	6400

Model	Height (in.)	Inside Width (in.)	Inside Length (in.)	Capacity	Weight (Lb.)
SSH - 7	48	63	143	7 YDS	6160
SSH - 9	48	63	164	9 YDS	6670
SSH - 12	48	75	183	12 YDS	7480
SSH - 15	48	75	222	15 YDS	8740
SSH - 18	60	81	219	18 YDS	9640
SSH - 20	60	81	239	20 YDS	10440

Model	Height (in.)	Inside Width (in.)	Inside Length (in.)	Capacity	Weight (Lb.)
SSHW - 9	48	75	146	9 YDS	6725
SSHW - 12	48	87	164	12 YDS	7730
SSHW - 15	48	87	195	15 YDS	8510
SSHW - 18	60	87	201	18 YDS	9620
SSHW - 20	60	87	220	20 YDS	10300

PRO-GRIDS

Reduce site clean-up cost

Pro-Tec Equipment's Pro-Grids are a portable, virtually maintenance-free product that serves as a means to eliminate track-out by removing mud, dirt and debris from the underbodies and tires of on-the-job vehicles.

Standard features:

- 10" deep - Extends the time between debris removal
- Centered lifting point

Pro-Grid options:

- Ramps - allow vehicle to ease on and off
- Connector tabs - to accommodate uneven terrain and increase grid stability
- Connector tabs use existing Pro-Tec Equipment Slide Rail H-Brackets and pins

Pro-Grid & Ramp

Model	Ht x Lgth x Width (in.)	Weight (Lb.)
PG - 812	10 X 96 X 144	2400
PG - R	10 X 48 X 144	970
PG - 720	10 X 84 X 240	3500
PG - R20	10 X 48 X 240	1620

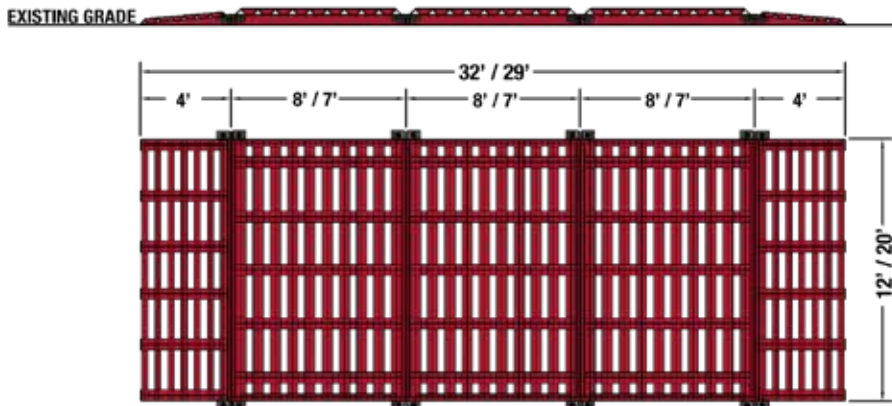
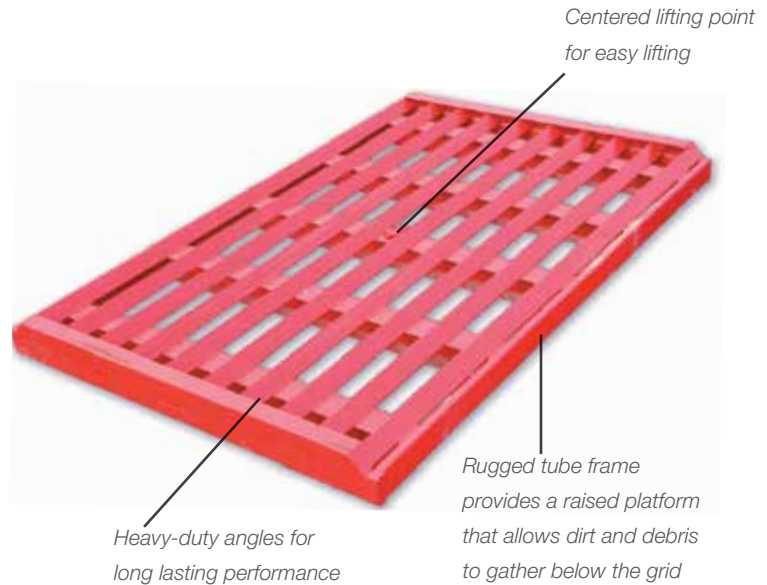

*Assumes one (1) tire rotation is equal to about 11'

Pro-Grid Setup - 3 Tire Rotations:

Shown using the Pro-Grid Ramps and optional connector tab, three Pro-Grids and two ramps are setup allowing for 29'-32' of travel. Using the Pro-Grid Ramps allow for the tire system to be setup above existing grade, such as on paved areas.

Pro-Grid Setup - 2 Tire Rotations:

Three Pro-Grids are setup allowing for 21'-24' of travel. Not using the Pro-Grid Ramps, the Grid system is shown buried 6" below existing grade to allow for easy traversing and increased stability.

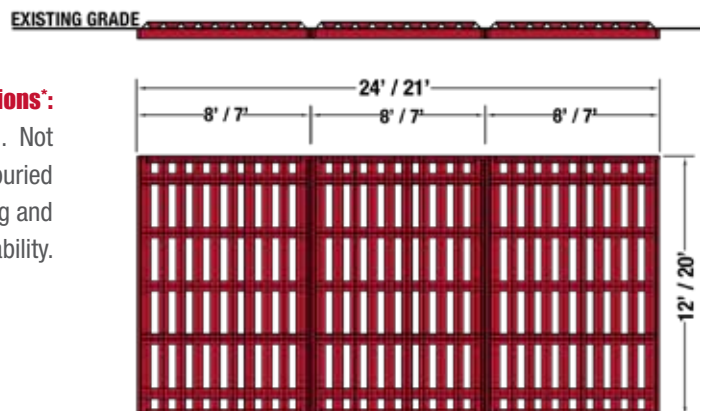



PRO-TEC EQUIPMENT

4837 West Grand River Ave
Lansing, MI 48906
Phone: 1-800-292-1225
Fax: (517) 827-3263
www.pro-tecequipment.com

The information in this brochure is presented in good faith to assist the user in determining whether our products are suitable for his/her application. No warranty or representation, however, is intended or made, nor is protection from any law or patent to be inferred, and all patent rights are reserved. Job site photos are strictly intended for general product information only and may not comply with all applicable safety standards. Always refer to manufacturer's specific tabulated data, O.S.H.A. 29 CFR 1926 Subpart P for excavation and all applicable safety standards prior to each use. ©201 Pro-Tec Equipment. All rights reserved.

ARCOSA
SHORING PRODUCTS